

K.100.258 (KO)

Модель



K - конвектор с естественной конвекцией (без вентилятора)
O - конвектор с отводом для слива конденсата

100

Высота, мм.

258

Ширина, мм.

147-1341

Теплоотдача, Вт.

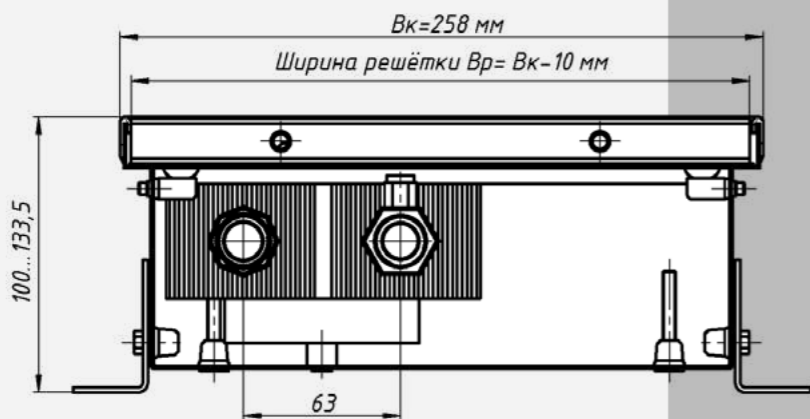

Артикул	Длина	Вес, кг	Теплоотдача (95/85/20), Вт	Без решетки	Стоимость решетки	С решеткой и окантовкой
K.100.258.600.2TG	600	6,05	147	12091	6532	18623
K.100.258.650.2TG	650	6,46	172	12632	7077	19709
K.100.258.700.2TG	700	6,89	197	13174	7621	20795
K.100.258.750.2TG	750	7,30	221	13715	8165	21881
K.100.258.800.2TG	800	7,71	246	14408	8710	23118
K.100.258.850.2TG	850	8,13	271	14949	9254	24204
K.100.258.900.2TG	900	8,54	298	15491	9799	25289
K.100.258.950.2TG	950	8,97	320	16032	10343	26375
K.100.258.1000.2TG	1000	9,38	347	16611	10887	27498
K.100.258.1050.2TG	1050	9,80	370	17153	11432	28584
K.100.258.1100.2TG	1100	10,21	395	17694	11976	29670
K.100.258.1150.2TG	1150	10,62	420	18236	12520	30756
K.100.258.1200.2TG	1200	11,09	444	18777	13065	31842
K.100.258.1250.2TG	1250	11,50	472	19318	13609	32927
K.100.258.1300.2TG	1300	11,92	494	19860	14153	34013
K.100.258.1350.2TG	1350	12,33	519	20401	14698	35099
K.100.258.1400.2TG	1400	12,76	543	20943	15242	36185
K.100.258.1450.2TG	1450	13,17	568	21484	15787	37271
K.100.258.1500.2TG	1500	13,74	596	22578	16331	38909
K.100.258.1550.2TG	1550	14,14	618	23120	16875	39995
K.100.258.1600.2TG	1600	14,55	642	23661	17420	41081
K.100.258.1650.2TG	1650	14,98	667	24203	17964	42167
K.100.258.1700.2TG	1700	15,39	692	24744	18508	43252
K.100.258.1750.2TG	1750	15,82	721	25286	19053	44338
K.100.258.1800.2TG	1800	16,22	742	25827	19597	45424
K.100.258.1850.2TG	1850	16,65	766	26368	20141	46510
K.100.258.1900.2TG	1900	17,06	791	26910	20686	47596
K.100.258.1950.2TG	1950	17,51	816	27451	21230	48681
K.100.258.2000.2TG	2000	18,03	820	28233	21775	50008
K.100.258.2050.2TG	2050	18,44	865	28775	22319	51094
K.100.258.2100.2TG	2100	18,86	890	29316	22863	52180
K.100.258.2150.2TG	2150	19,27	915	29858	23408	53265
K.100.258.2200.2TG	2200	19,70	940	30399	23952	54351
K.100.258.2250.2TG	2250	20,11	956	30941	24496	55437
K.100.258.2300.2TG	2300	20,52	989	31482	25041	56523
K.100.258.2350.2TG	2350	20,94	1014	32023	25585	57609
K.100.258.2400.2TG	2400	21,35	1039	32565	26129	58694
K.100.258.2450.2TG	2450	21,92	1063	33106	26674	59780
K.100.258.2500.2TG	2500	22,33	1093	34201	27218	61419
K.100.258.2550.2TG	2550	22,76	1113	34893	27762	62656
K.100.258.2600.2TG	2600	23,16	1138	35435	28307	63742
K.100.258.2650.2TG	2650	23,59	1163	35976	28851	64828
K.100.258.2700.2TG	2700	24,04	1187	36518	29396	65913
K.100.258.2750.2TG	2750	24,45	1217	37059	29940	66999
K.100.258.2800.2TG	2800	24,87	1237	37601	30484	68085
K.100.258.2850.2TG	2850	25,28	1262	38142	31029	69171
K.100.258.2900.2TG	2900	25,71	1286	38683	31573	70257
K.100.258.2950.2TG	2950	26,12	1311	39225	32117	71342
K.100.258.3000.2TG	3000	26,55	1341	39951	32662	72613

